

PRODUCT CARD

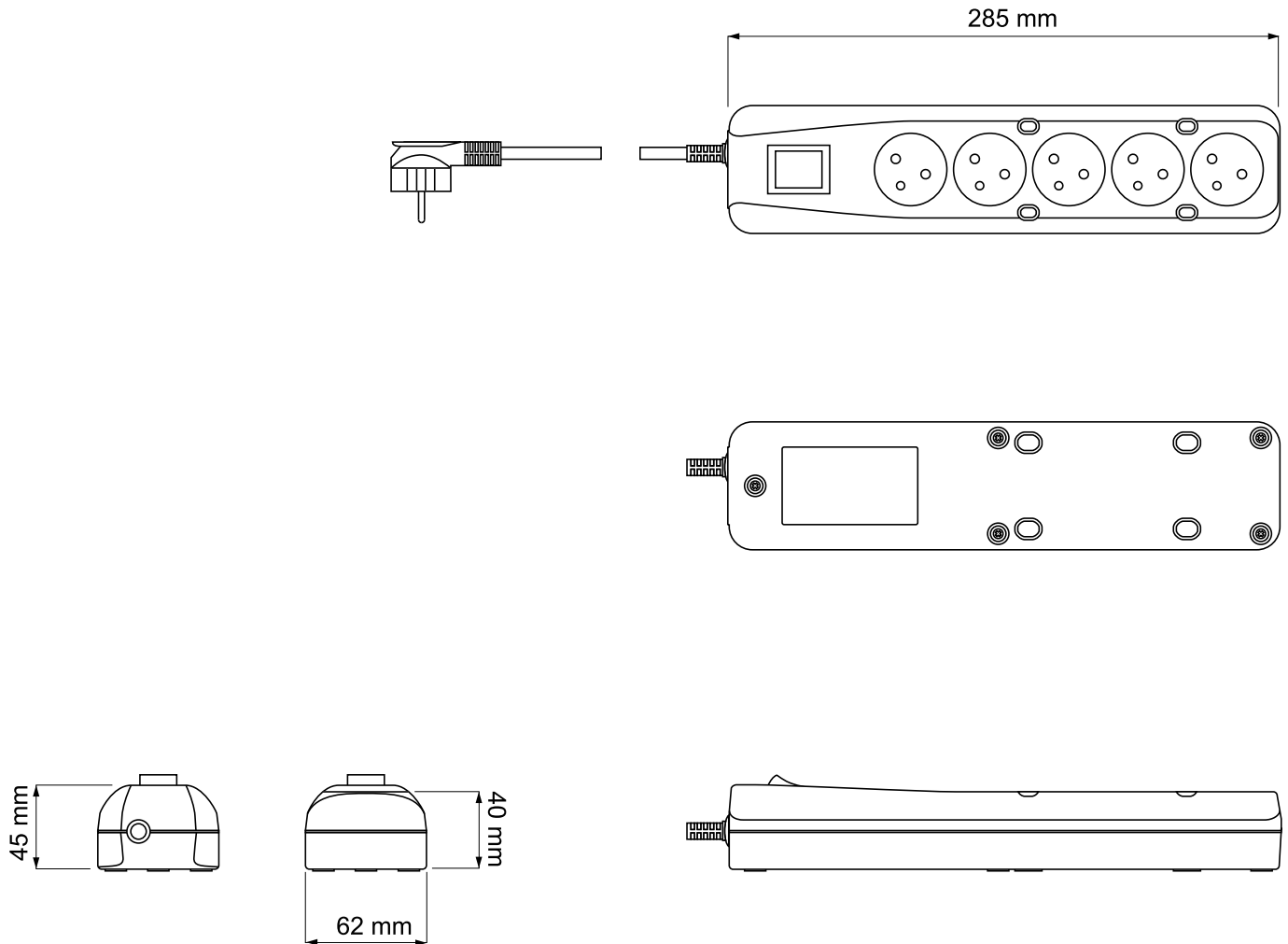

Extension cord LP-530W



Technical Data:

Continuous operating voltage U_c	~250V, 50Hz
Voltage rating U_N	~230V, 50Hz
Rated current ΣI_N	16A
Switch	Illuminated
Cable length	L-1,5÷5,0m

DATE:	PREPARED:	CONFIRMED:	MODEL:	PAGE 1
			LP-530W	KK-27/EN